



Type 6281 can be combined with...



Type 2508

## Servo-assisted 2/2 way diaphragm valve

- Servo-assisted diaphragm with diameter of up to DN50
- Vibration-proof, central screwed coil system
- Damped design for quiet closing
- Service-friendly manual override
- Explosion-proof versions

The 6281 valve is a servo-assisted solenoid valve of the S.EV series. A minimum differential pressure is always required for the function of the valve. Various diaphragm material combinations and methods of operation are available depending on the application. The standard brass housing satisfies all European drinking water requirements. Dezincification-resistant brass is available for other markets. The housing offering is rounded out by a stainless steel version. For reduced energy requirement, all coils can be delivered with electronic power reduction. The valve can be equipped with manual override for easy maintenance and commissioning. In combination with a plug in accordance with DIN EN 175301-803 Form A, the valves satisfy protection class IP65 – in combination with a stainless steel housing NEMA 4X.

Technical data	
<b>Orifice</b>	DN10 - 50 mm
<b>Body material</b>	Brass acc. to DIN EN 50930-6 (Stainless steel, dezincification resistant on request)
<b>Inner part of valve</b>	Stainless steel, Brass, Plastic (PPS)
<b>Seal material</b>	NBR, EPDM, FKM
<b>Media</b>	NBR EPDM FKM
	Neutral fluids, e.g. compressed air, water Oil and fat-free fluids, hot water, acetone, aqueous alkali solution Hot air, per-solution
<b>Ambient temperature</b>	max. +55 °C
<b>Media temperature</b>	NBR EPDM FKM
	-10° to +80 °C -30° to +90 °C (with epoxy coil to +100 °C) 0° to +90 °C (with epoxy coil to +120 °C)
<b>Voltages</b>	024/DC, 024/50-60, 230/50-60
<b>Voltage tolerance</b>	± 10 %
<b>Duty cycle</b>	100 % continuous rating
<b>Electrical connection</b>	Tag connector acc. to DIN EN 175301-803 Form A (previously DIN 43650) for cable plug Type 2508 (see Ordering chart for accessory, p. 12)
<b>Protection class</b>	IP65 with cable plug and cable connection IP65 with junction box
<b>Installation</b>	As required, preferably with actuator upright
<b>Response times<sup>2)</sup></b>	0.1 - 4 sec.ds (depending on orifice and differential pressure)
<b>Coil isolation class</b>	Polyamide class B Epoxy class H

<sup>2)</sup> Measured at valve outlet at 6 bar and +20 °C. *Opening:* pressure build-up 0 to 90 %, *Closing:* pressure decay 100 to 10 %

### Content:

<b>Technical data</b>	p. 1-2
<b>Standard version</b>	
Dimensions	p. 3
Ordering chart	p. 4-7
<b>Explosion-proof version</b>	
Dimensions	p. 8-9
Ordering chart	p. 10
<b>Compressor relief version</b>	
Ordering chart & Dimensions	p. 11
<b>Further versions</b>	p. 12
<b>Accessory</b>	p. 12-13

### Circuit function A

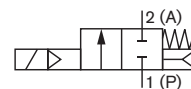

2/2-way solenoid valve  
servo-assisted,  
normally closed

### Circuit function B

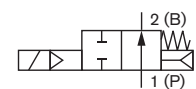

2/2-way solenoid  
servo assisted,  
normally open

## Power consumption

Power consumption							
Orifice [mm]	coil size [mm]	AC			DC		ATEX AC/DC nominal power [W]
		inrush power [VA]	holding power [VA]	[W]	cold power [W]	warm power [W]	
10-50 WWA	32	24	14	8	9.5	8	-
10-50 WWB	32	24	16	7	9.5	8	-
10-50 WWA/B	40	-	-	-	-	-	7
10 WWA	32	-	-	-	-	-	7
10 WWB	40	-	-	-	-	-	9
10 WWB & CF05	32	18	11	5	6	5	-

## Materials

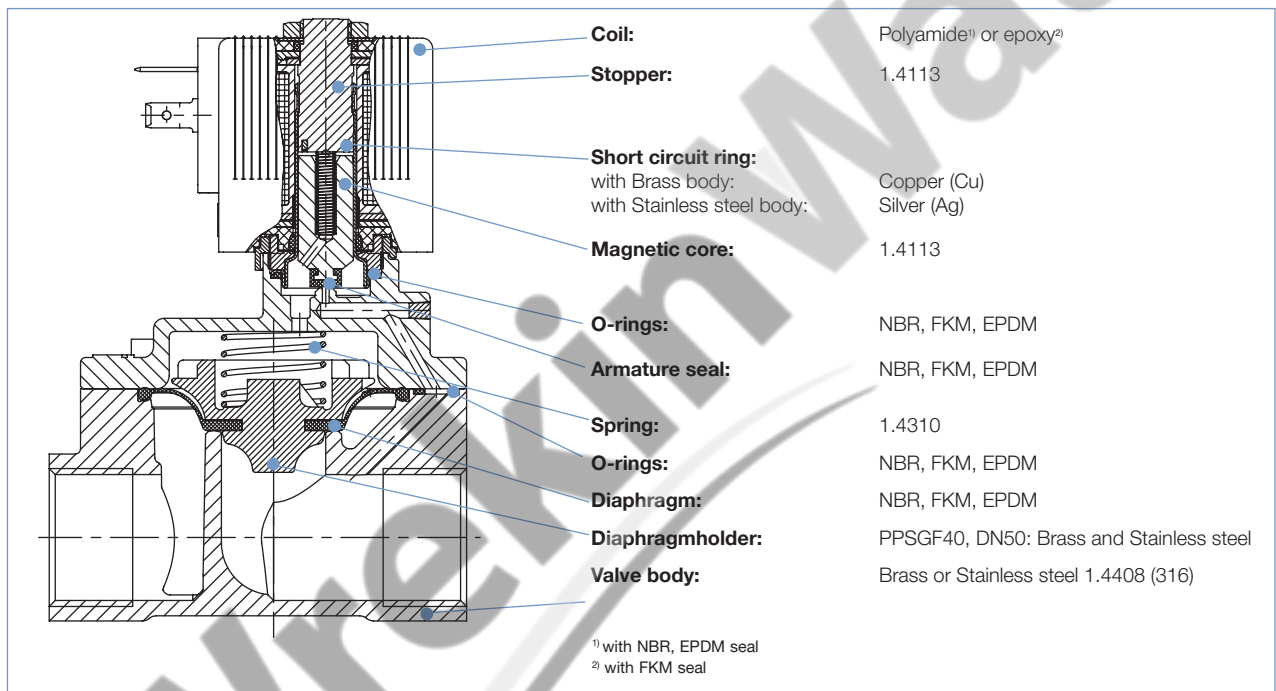

Dimensions [mm]

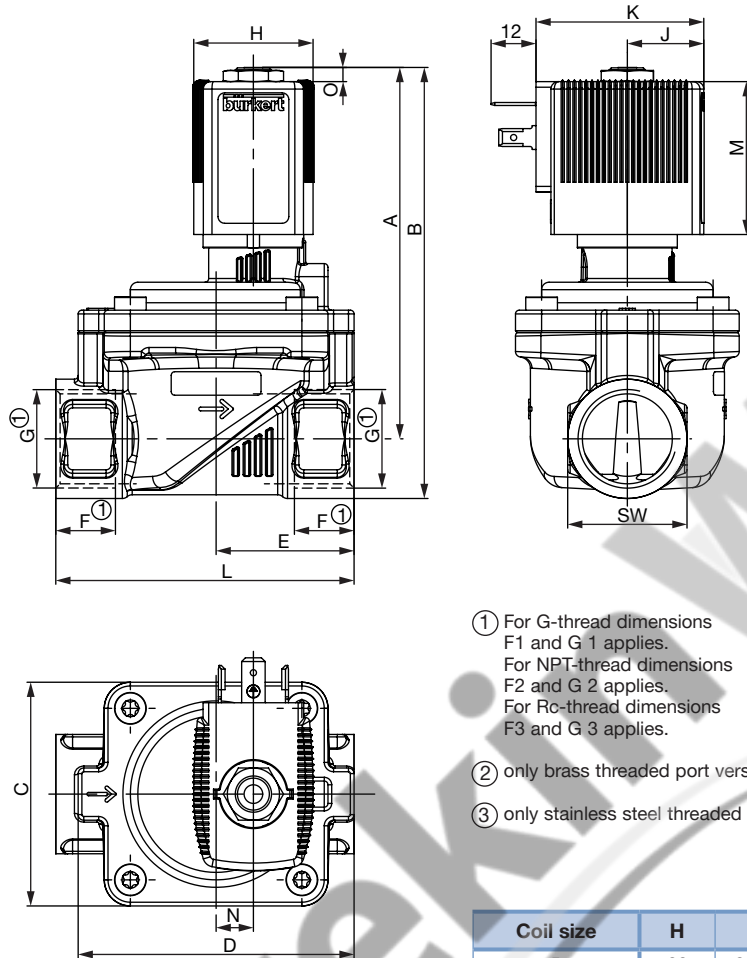

- ① For G-thread dimensions F1 and G 1 applies.  
For NPT-thread dimensions F2 and G 2 applies.  
For Rc-thread dimensions F3 and G 3 applies.
- ② only brass threaded port version
- ③ only stainless steel threaded port version

Coil size	H	J	K	M	O
5	32	20.5	45	41	3.4
6	40	23.5	51	41.4	3.8

	DN	A	B	C	D	E	* G		* NPT		* Rc		L	SW	N
							F1 ①	G 1 ①	F2 ①	G 2 ①	F3 ①	G 3 ①			
②	10	83.1	94.1	32	44	22	12	G ¼	10	NPT ¼	-	-	50	22	-
							12	G ⅜	10.3	NPT ⅜	10.1	Rc ⅜			
②	10	85.1	98.6			24.5	14	G ½	13.7	NPT ½	-	-	50	27	-
									12	G ¼	10	NPT ¼			
③	10	83.6	94.6	24.5	14	G ½	13.7	NPT ½	10.1	Rc ⅜	50	22	-		
							14	G ½	13.7	NPT ½				-	-
②	13	91.1	104.6	42	54.5	27.25	12	G ⅝	-	-	-	-	58	27	-
							14	G ½	13.7	NPT ½	13.2	Rc ½			
13	93.1	109.1	32.5			16	G ¾	14	NPT ¾	-	-	65	32	-	
															16
20	99.6	115.6	60	74	37	16	G ¾	14	NPT ¾	14.5	Rc ¾	80	32	10	
															37.5
25	106.6	127.1	70	85	46	18	G 1	16.8	NPT 1	16.8	Rc 1	95	41	15	
															20
②	40	120.1	145.1	99	114	61	20	G 1¼	17.3	NPT 1¼	19.1	Rc 1¼	126	50	23
40	125.6	155.6	64			24	G 2	17.6	NPT 2	23.4	Rc 2	132	70	-	
															24
②	50	119.9	154.9	82	24	G 2	17.6	NPT 2	23.4	Rc 2	164	70	37		
														119.6	162.1

## Ordering chart for valves, (other versions on request)

## Circuit function A (NC, normally closed), Brass body

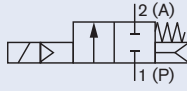
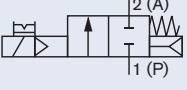
Circuit function	Port connection	Orifice [mm]	K <sub>v</sub> value water [m <sup>3</sup> /h]	Pressure range [bar]	Weight [kg]	Article no. per voltage/frequency [V/Hz]		
						024/DC	024/50-60	230/50-60
<b>A 2/2 way valve NC</b> 	<b>Seal material NBR, Polyamide coil, Medium temperature -10...+80 °C</b>							
	G ¼	10	1.5	0.2-16	0.43	322499	322500	322501
	G ¾	10	1.9	0.2-16	0.40	322502	322503	322504
	G ¾	13	3.8	0.2-16	0.58	221841	221842	221843
	G ½	13	3.8	0.2-16	0.54	221844	221845	221846
	G ¾	13	3.8	0.2-16	0.59	221847	221848	221849
	G ¾	20	8.5	0.2-16	0.89	221850	221851	221852
	G 1	20	8.5	0.2-16	1.0	221853	221854	221855
	G 1	25	12	0.2-16	1.3	221856	221857	221858
	G 1¼	25	12	0.2-16	1.5	221859	221860	221861
	G 1¼	40	23	0.2-16	2.7	270131	268550	270132
	G 1½	40	30	0.2-16	3.0	221862	221863	221864
	G 2	40	30	0.2-16	3.2	221865	221866	221867
	G 2	50	40	0.2-16	4.5	253156	253157	253158
	G 2½	50	40	0.2-16	5.2	253159	253160	253161
<b>A 2/2 way valve NC, manual override</b> 	<b>Seal material NBR, Polyamide coil, Medium temperature -10...+80 °C, with manual override</b>							
	G ¼	10	1.5	0.2-16	0.43	322505	322506	322507
	G ¾	10	1.9	0.2-16	0.40	322508	322509	322510
	G ½	13	3.8	0.2-16	0.54	221952	-	221953
	G ¾	13	3.8	0.2-16	0.59	221954	-	221955
	G ¾	20	8.5	0.2-16	0.89	221956	-	221957
	G 1	20	8.5	0.2-16	1.0	221958	-	221959
	G 1	25	12	0.2-16	1.3	221960	-	221961
	G 1¼	25	12	0.2-16	1.5	221962	-	221963
	G 1¼	40	23	0.2-16	2.7	270142	-	270143
	G 1½	40	30	0.2-16	3.0	221964	-	221965
	G 2	40	30	0.2-16	3.2	221966	-	221967

Please note that the cable plug has to be ordered separately, see Ordering chart for accessory and separate datasheet, Type 2508.

## Ordering chart for valves, continued

## Circuit function A (NC, normally closed), Brass body

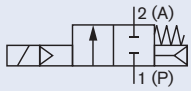
Circuit function	Port connection	Orifice [mm]	K <sub>v</sub> value water [m <sup>3</sup> /h]	Pressure range [bar]	Weight [kg]	Article no. per voltage/frequency [V/Hz]			
						024/DC	024/50 - 60	230/50 - 60	
<b>A 2/2-Wege-Ventil NC</b> 	<b>Seal material FKM, Epoxy coil, Medium temperature 0 ... +120 °C</b>								
	G ¼	10	1.5	0.2 - 16	0.43	322511	322512	322513	
	G ⅜	10	1.9	0.2 - 16	0.40	322514	322515	322516	
	G ⅜	13	3.8	0.2 - 16	0.58	221868	221869	221870	
	G ½	13	3.8	0.2 - 16	0.54	221871	221872	221873	
	G ¾	13	3.8	0.2 - 16	0.59	221874	221875	221876	
	G ¾	20	8.5	0.2 - 16	0.89	221877	221878	221879	
	G 1	20	8.5	0.2 - 16	1.0	221880	221881	221882	
	G 1	25	12	0.2 - 16	1.3	221883	221884	221885	
	G 1¼	25	12	0.2 - 16	1.5	221886	221887	221888	
	G 1¼	40	23	0.2 - 16	2.7	270133	270134	270135	
	G 1½	40	30	0.2 - 16	3.0	221889	221890	221891	
	G 2	40	30	0.2 - 16	3.2	221892	221893	221894	
	G 2	50	40	0.2 - 16	4.5	253168	253169	253170	
	G 2½	50	40	0.2 - 16	5.2	253171	253172	253173	
	<b>Seal material EPDM, Polyamide coil, Medium temperature -30 ... +90 °C</b>								
	G ¼	10	1.5	0.2 - 16	0.43	322517	322518	322519	
	G ⅜	10	1.9	0.2 - 16	0.40	322520	322521	322522	
	G ⅜	13	3.8	0.2 - 16	0.58	221895	221896	221897	
	G ½	13	3.8	0.2 - 16	0.54	221898	221899	221900	
	G ¾	13	3.8	0.2 - 16	0.59	221901	221902	221903	
	G ¾	20	8.5	0.2 - 16	0.89	221904	221905	221906	
	G 1	20	8.5	0.2 - 16	1.0	221907	221908	221909	
	G 1	25	12	0.2 - 16	1.3	221910	221911	221912	
	G 1¼	25	12	0.2 - 16	1.5	221913	221914	221915	
	G 1¼	40	23	0.2 - 16	2.7	270136	270137	270138	
	G 1½	40	30	0.2 - 16	3.0	221916	221917	221918	
	G 2	40	30	0.2 - 16	3.2	221919	221920	221921	
	G 2	50*	40	0.2 - 16	4.5	253162	253163	253164	
	G 2½	50*	40	0.2 - 16	5.2	253165	253166	253167	

\*Drinking water approved acc. to KTW and W270.

## Circuit function B (NO, normally open), Brass body

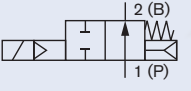
Circuit function	Port connection	Orifice [mm]	K <sub>v</sub> value water [m <sup>3</sup> /h]	Pressure range [bar]	Weight [kg]	Article no. per voltage/frequency [V/Hz]			
						024/DC	024/50	230/50	
<b>B 2/2-Wege-Ventil NO</b> 	<b>Seal material NBR, Epoxy coil, Medium temperature -10 ... +80 °C</b>								
	G ¼	10	1.5	0.2 - 16	0.43	322523	322524	322525	
	G ⅜	10	1.9	0.2 - 16	0.40	322526	322527	322528	
	G ⅜	13	3.8	0.2 - 16	0.58	221923	221924	221925	
	G ½	13	3.8	0.2 - 16	0.54	221926	221928	221929	
	G ¾	13	3.8	0.2 - 16	0.59	221930	221931	221933	
	G ¾	20	8.5	0.2 - 16	0.89	221934	221935	221936	
	G 1	20	8.5	0.2 - 16	1.0	221937	221938	221939	
	G 1	25	12	0.2 - 16	1.3	221940	221941	221942	
	G 1¼	25	12	0.2 - 16	1.5	221943	221944	221945	
	G 1¼	40	23	0.2 - 16	2.7	270139	270140	270141	
	G 1½	40	30	0.2 - 16	3.0	221946	221947	221948	
	G 2	40	30	0.2 - 16	3.2	221949	221950	221951	
	G 2	50	40	0.2 - 16	4.5	253174	253175	253176	
	G 2½	50	40	0.2 - 16	5.2	253177	253178	253179	

Please note that the cable plug has to be ordered separately, see Ordering chart for accessory and separate datasheet, Type 2508.

## Ordering chart for valves, continued



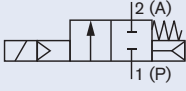







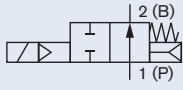













## Circuit function A (NC, normally closed), Stainless steel body

Circuit function	Port connection	Orifice [mm]	K <sub>v</sub> value water [m <sup>3</sup> /h]	Pressure range [bar]	Weight [kg]	Article no. per voltage/frequency [V/Hz]		
						024/DC	024/50-60	230/50-60
A 2/2 way valve NC 	<b>Seal material NBR, Polyamide coil, Medium temperature -10...+80 °C</b>							
	G ¼	10	1.5	0.2-16	0.43	322529	322530	322531
	G ⅜	10	1.9	0.2-16	0.40	322532	322533	322534
	G ½	13	3.8	0.2-16	0.54	221968	221969	221970
	G ¾	20	8.5	0.2-16	0.86	221971	221972	221973
	G 1	20	8.5	0.2-16	0.97	221974	221975	221976
	G 1	25	12	0.2-16	1.3	221977	221978	221979
	G 1¼	25	12	0.2-16	1.4	221980	221981	221982
	G 1½	40	30	0.2-16	2.8	221983	221984	221985
	G 2	40	30	0.2-16	3.0	221986	221987	221988
	<b>Seal material FKM, Epoxy coil, Medium temperature 0...+120 °C</b>							
	G ¼	10	1.5	0.2-16	0.43	322535	322536	322537
	G ⅜	10	1.9	0.2-16	0.40	322538	322539	322540
	G ½	13	3.8	0.2-16	0.54	221989	221990	221991
	G ¾	20	8.5	0.2-16	0.86	221992	221993	221994
	G 1	20	8.5	0.2-16	0.97	221995	221996	221997
	G 1	25	12	0.2-16	1.3	221998	221999	222000
	G 1¼	25	12	0.2-16	1.4	222001	222002	222003
	G 1½	40	30	0.2-16	2.8	222004	222005	222006
	G 2	40	30	0.2-16	3.0	222007	222008	222009
	<b>Seal material FKM, Epoxy coil, Medium temperature 0...+120 °C, with manual override</b>							
	G ¼	10	1.5	0.2-16	0.43	323894	-	323968
	G ⅜	10	1.9	0.2-16	0.40	323971	-	323972
	G ½	13	3.8	0.2-16	0.54	323973	-	323975
	G ¾	20	8.5	0.2-16	0.86	323977	-	323978
	G 1	25	12	0.2-16	1.3	323979	-	323980
	G 1¼	25	1.4	0.2-16	1.4	323982	-	323984
	G 1½	40	30	0.2-16	2.8	323986	-	323987
	G 2	40	30	0.2-16	3.0	323988	-	323989
	<b>Seal material EPDM, Polyamide coil, Medium temperature -30...+90 °C</b>							
	G ¼	10	1.5	0.2-16	0.43	322541	322542	322543
	G ⅜	10	1.9	0.2-16	0.40	322544	322545	322546
	G ½	13	3.8	0.2-16	0.54	222010	222011	222012
	G ¾	20	8.5	0.2-16	0.86	222013	222014	222015
	G 1	20	8.5	0.2-16	0.97	222016	222017	222018
	G 1	25	12	0.2-16	1.3	222019	222020	222021
	G 1¼	25	12	0.2-16	1.4	222022	222023	222024
G 1½	40	30	0.2-16	2.8	222025	222026	222027	
G 2	40	30	0.2-16	3.0	222028	222029	222031	



## Ordering chart for valves, continued

## Circuit function B (NO, normally open), Stainless steel body

Circuit function	Port connection	Orifice [mm]	K <sub>v</sub> value water [m <sup>3</sup> /h]	Pressure range [bar]	Weight [kg]	Article no. per voltage/frequency [V/Hz]		
						024/DC	024/50	230/50
<b>B 2/2 way valve NO</b> 	<b>Seal material FKM, Epoxy coil, Medium temperature 0... +120 °C</b>							
	G ¼	10	1.5	0.2 - 16	0.43	322547 	322548 	322549 
	G ¾	10	1.9	0.2 - 16	0.40	322550 	322551 	322552 
	G ½	13	3.8	0.2 - 16	0.54	228387 	228388 	228389 
	G ¾	20	8.5	0.2 - 16	0.86	228390 	228391 	228392 
	G 1	25	12	0.2 - 16	1.3	228393 	228394 	228395 
	G 1¼	25	12	0.2 - 16	1.4	228396 	228397 	228398 
	G 1½	40	30	0.2 - 16	2.8	228399 	228400 	228401 
	G 2	40	30	0.2 - 16	3.0	228402 	228403 	228404 

Please note that the cable plug has to be ordered separately, see Ordering chart for accessory and separate datasheet, Type 2508.

Dimensions [mm] - ATEX

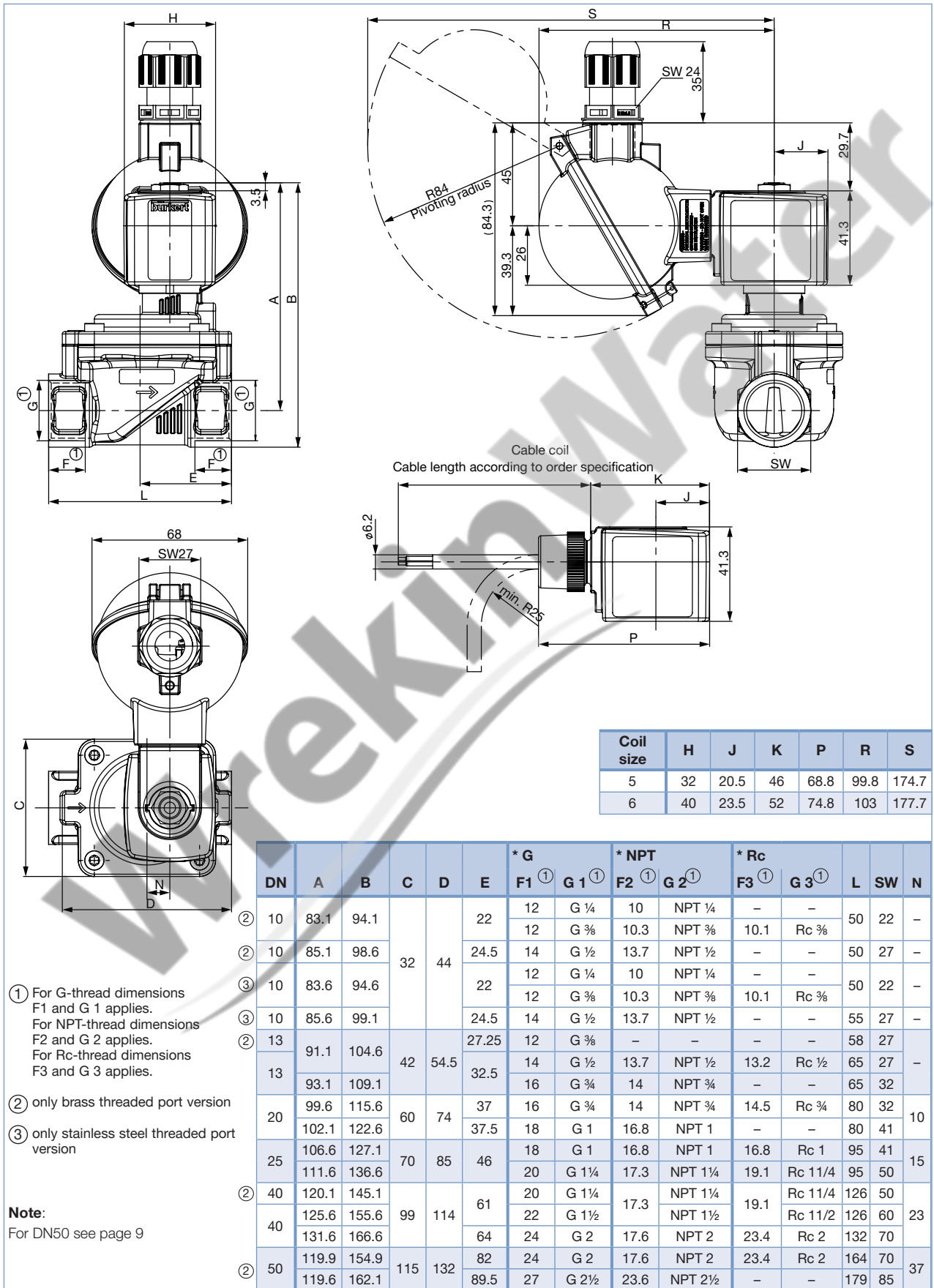

- ① For G-thread dimensions F1 and G 1 applies. For NPT-thread dimensions F2 and G 2 applies. For Rc-thread dimensions F3 and G 3 applies.
- ② only brass threaded port version
- ③ only stainless steel threaded port version

**Note:**  
For DN50 see page 9



Dimensions [mm] - ATEX

Rotated view of the junction box

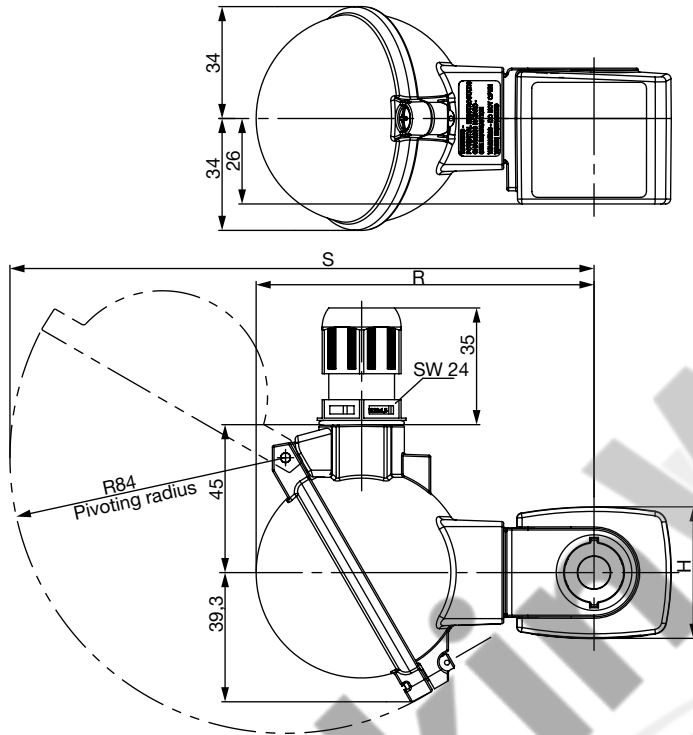

Coil size	H	J	K	P	R	S
5	32	20.5	46	68.8	99.8	174.7
6	40	23.5	52	74.8	103	177.7

Note: Standard at DN50

## Ordering chart for valves, continued

Circuit function A, (NC, normally closed)<sup>1)</sup> explosion proofed version ATEX and IECEx  
Electrical connection with 3 m cable

The maximum fluid temperature must not in any case exceed the permissible temperature class (T4 135 °C, 100 °C T5, T6 85 °C), minus 5 K.

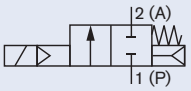
Circuit function	Port connection	Orifice [mm]	K <sub>v</sub> value water [m <sup>3</sup> /h]	Pressure range [bar]	Weight [kg]	Article no. per voltage/frequency [V/Hz]	
						024/UC	230/UC
 A 2/2 way valve NC	<b>Seal material NBR, Brass body, Medium temperature -10... +80 °C</b>						
	G ¼	10	1.5	0.2-16	0.62	322553	322554
	G ⅜	10	1.9	0.2-16	0.59	322555	322556
	G ½	13	3.8	0.2-16	0.84	277539	277535
	G ¾	20	8.5	0.2-16	1.2	278095	278097
	G 1	25	12	0.2-16	1.7	277543	277540
	G 1¼	25	12	0.2-16	1.8	278103	278105
	G 1¼	40	23	0.2-16	3.0	279557	279558
	G 1½	40	30	0.2-16	3.3	278106	278107
	G 2	40	30	0.2-16	3.5	278191	278250
	G 2	50	40	0.2-16	4.8	278109	278112
	G 2½	50	40	0.2-16	5.5	278248	278249
	<b>Seal material FKM, Stainless steel body, Medium temperature 0... +90 °C</b>						
	G ¼	10	1.5	0.2-16	0.62	322557	322558
	G ⅜	10	1.9	0.2-16	0.59	322559	322560
	G ½	13	3.8	0.2-16	0.84	277545	277544
	G ¾	20	8.5	0.2-16	1.2	278187	278188
	G 1	25	12	0.2-16	1.6	277547	277546
	G 1¼	25	12	0.2-16	1.7	278251	278252
	G 1½	40	30	0.2-16	3.1	278193	278194
	G 2	40	30	0.2-16	3.3	278253	278254

Circuit function A, (NC, normally closed)<sup>1)</sup> explosion proofed version ATEX and IECEx  
Electrical connection with junction box

The maximum fluid temperature must not in any case exceed the permissible temperature class (T4 135 °C, 100 °C T5, T6 85 °C), minus 5 K.

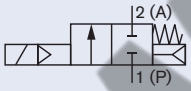
Circuit function	Port connection	Orifice [mm]	K <sub>v</sub> value water [m <sup>3</sup> /h]	Pressure range [bar]	Weight [kg]	Article no. per voltage/frequency [V/Hz]	
						024/UC	230/UC
 A 2/2 way valve NC	<b>Seal material NBR, Brass body, Medium temperature -10... +80 °C</b>						
	G ¼	10	1.5	0.2-16	0.62	322561	322562
	G ⅜	10	1.9	0.2-16	0.59	322563	322564
	G ½	13	3.8	0.2-16	0.84	289544	289550
	G ¾	20	8.5	0.2-16	1.2	289560	289561
	G 1	25	12	0.2-16	1.7	289565	289568
	G 1¼	25	12	0.2-16	1.8	289571	289572
	G 1¼	40	23	0.2-16	3.0	289575	289576
	G 1½	40	30	0.2-16	3.3	289577	289579
	G 2	40	30	0.2-16	3.5	289583	289584
	G 2	50	40	0.2-16	4.8	289587	289591
	<b>Seal material FKM, Stainless steel body, Medium temperature 0... +90 °C</b>						
	G ¼	10	1.5	0.2-16	0.62	322565	322566
	G ⅜	10	1.9	0.2-16	0.59	322567	322568
	G ½	13	3.8	0.2-16	0.84	289556	289557
	G ¾	20	8.5	0.2-16	1.2	289562	289563
	G 1	25	12	0.2-16	1.6	289569	289570
	G 1¼	25	12	0.2-16	1.7	289573	289574
	G 1½	40	30	0.2-16	3.1	289580	289581
	G 2	40	30	0.2-16	3.3	289585	289586

<sup>1)</sup> only with Epoxy coil available

Explosion proofed approvals

ATEX: PTB 14 ATEX 2023 X

II 2G Ex mb IIC T4 Gb

II 2D Ex mb IIIC T130 °C Db

IECEX: IECEX PTB 14.0049 X

Ex mb IIC T4 Gb

Ex mb IIIC T130 °C Db

## ATEX and IECEx approval for assembling coil and terminal box

ATEX: EPS 16 ATEX 1046 X

II 2G Ex eb mb IIC T4 Gb

II 2D Ex mb tb IIIC T130 °C Db

IECEX: IECEX EPS 16.0021 X

Ex eb mb IIC T4 Gb

Ex mb tb IIIC T130 °C Db

Compressor relief valve

Circuit function B (NO, normally open), brass body

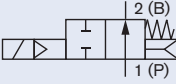
Circuit function	Port connection	Orifice [mm]	K <sub>v</sub> value water [m <sup>3</sup> /h]	Pressure range [bar]	Weight [kg]	Article no. per voltage/frequency [V/Hz]			
						024/DC	024/50-60	110/50-60	230/50-60
B 2/2 way valve NO 	Seal material FKM, polyamide coil, medium temperature 0...+90 °C, DN10_CF05								
	G 3/8	10	1,9	0,2 - 16	0,43	330985	330986	330987	330988
	G 1/2	10	1,9	0,2 - 16	0,40	330989	331007	331008	331009
	Seal material FKM, polyamide coil, medium temperature 0...+90 °C, DN13								
	G 3/8	13	3,6	0,5 - 16	0,58	310663	310662	310661	310659
	G 1/2	13	3,6	0,5 - 16	0,54	310667	310666	310665	310664

Please note that the cable plug has to be ordered separately, see Ordering chart for accessory and separate datasheet, Type 2508.

Note: In deenergized state the valve is open. The medium also flows off via the vent on the coil.

Dimensions [mm]

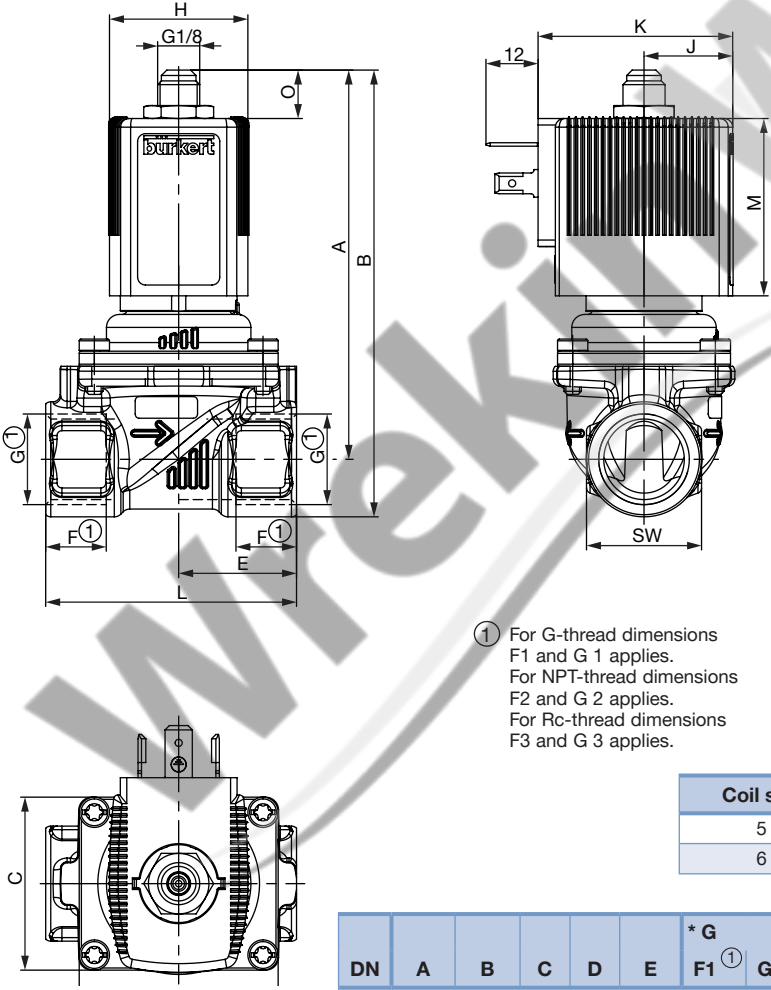

① For G-thread dimensions  
 F1 and G 1 applies.  
 For NPT-thread dimensions  
 F2 and G 2 applies.  
 For Rc-thread dimensions  
 F3 and G 3 applies.

Coil size	H	J	K	M	O
5	32	20.5	45	41	11.2
6	40	23.5	51	41.4	10.8

DN	A	B	C	D	E	* G		* NPT		* Rc		L	SW
						F1 ①	G 1 ①	F2 ①	G 2 ①	F3 ①	G 3 ①		
10	90.5	101.5	32	44	22	12	G 1/4	10	NPT 1/4	-	-	50	22
						12	G 3/8	10.3	NPT 3/8	10.1	Rc 3/8		
	24.5	14			G 1/2	13.7	NPT 1/2	13.2	Rc 1/2	27			
13	90	103.5	42	54.5	27.25	12	G 3/8	-	-	-	-	58	27
						14	G 1/2	13.7	NPT 1/2	13.2	Rc 1/2		
	32.5	16			G 3/4	14	NPT 3/4	14.5	Rc 3/4	65	32		
20	107	123	60	74	37	16	G 3/4	14	NPT 3/4	14.5	Rc 3/4	80	32
						18	G 1	16.8	NPT 1	-	-		
	37.5	18			G 1	16.8	NPT 1	-	-	41			

## **i** Further versions on request



**Port connection**  
NPT, Rc



**Temperature**  
EPDM version up to +100 °C with epoxy coil  
FKM version up to +120 °C with epoxy coil



**Voltage**  
Further voltages



**Material**  
Brass dezincification resistant



**Approvals**  
European drinking water approval  
acc. to KTW W270 (Var. code PF23)  
VDE sign permission acc. to  
DIN EN 60730 (Var. code PW01)

## Ordering chart for accessory

### Cable plug Type 2508 according to DIN EN 175301 - 803 Form A

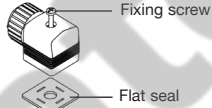
	Circuitry	Voltage / frequency	Article no.	
	None (standard)	0 - 250 V AC/DC	008376	
	None (for Stainless steel version)	0 - 250 V AC/DC	132445	
further versions see datasheet Type 2508				

The delivery of a cable plug includes the flat seal and the fixing screw. For other cable plug versions acc. to DIN EN 175301 - 803 Form A (previously DIN 43650), see separate datasheet Type 2508.

### Cable plug Type 2513 acc. to DIN EN 175301 - 803, Form A



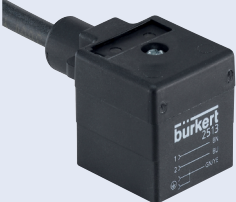
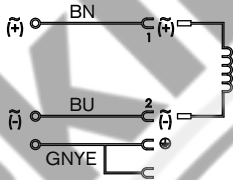

Meets the requirements of ATEX category 3 GD

Should only be used in connection with specially marked devices acc. to ATEX Cat. 3.

		Cable length [mm]	Article no. [in mm]
		12000	260893
		5000	260892
		3000	260891
		300	260890

## Ex-Cable glands

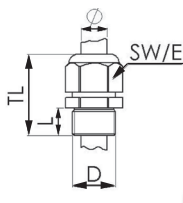
(polyamide version included in delivery / surcharge applied for brass nickel plated version)

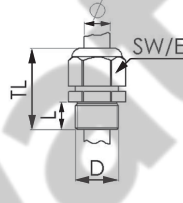
Photo	Description	Ex Approvals		Article no.	Drawing										
		Certification	Identification												
	Brass, nickelplated 6-13 mm	PTB 04 ATEX 1112 X, IECEX PTB 13.0027X	II 2 G Ex e IIC Gb, II 2 D Ex tb IIIC Db IP68	773278 	 <table border="1"> <tr><td>TL</td><td>29-37 mm</td></tr> <tr><td>L</td><td>6 mm</td></tr> <tr><td>D</td><td>20</td></tr> <tr><td>SW</td><td>24 mm</td></tr> <tr><td>E</td><td>27 mm</td></tr> </table>	TL	29-37 mm	L	6 mm	D	20	SW	24 mm	E	27 mm
TL	29-37 mm														
L	6 mm														
D	20														
SW	24 mm														
E	27 mm														
	Polyamide, 7-13 mm	PTB 13 ATEX 1015 X, IECEX PTB 13.0034X	II 2 G Ex e IIC Gb, II 2 D Ex tb IIIC Db IP68	773277 	 <table border="1"> <tr><td>TL</td><td>36-45 mm</td></tr> <tr><td>L</td><td>10 mm</td></tr> <tr><td>D</td><td>20</td></tr> <tr><td>SW</td><td>24 mm</td></tr> <tr><td>E</td><td>28 mm</td></tr> </table>	TL	36-45 mm	L	10 mm	D	20	SW	24 mm	E	28 mm
TL	36-45 mm														
L	10 mm														
D	20														
SW	24 mm														
E	28 mm														

## Special tool to turn the junction box (not included in delivery)

Photo	Description	Article no.
	Set SC02-AC10 Special wrench Service Manual	293488 

To find your nearest Bürkert facility, click on the orange box →

[www.burkert.com](http://www.burkert.com)In case of special application conditions,  
please consult for advice.Subject to alteration.  
© Christian Bürkert GmbH & Co. KG

1809/13\_EU-en\_00895124